



ATLANTA

Handling, Installation, Operation &
Maintenance Instructions

BWS 110e

4100-001-12.93

Department	TB
Rev. Index	G / Beh.
Date	2009-01-05

E Servo-Worm Reducers

Page	1	23
Name	Behrens	2008-05-20
Released	Lorch	2008-05-08



ATLANTA

Drive Systems

E Servo-Worm Reducers Operating Manual



ATLANTA

Handling, Installation, Operation & Maintenance Instructions

BWS 110e

4100-001-12.93

Department	TB
Rev. Index	G / Beh.
Date	2009-01-05

E Servo-Worm Reducers

Page	2	23
Name	Behrens	2008-05-20
Released	Lorch	2008-05-08



CAUTION! This operating manual is meant for all persons involved in the installation, operation and maintenance of ATLANTA Servo-Worm Reducers. To prevent damages and injuries, all instructions in this manual must be read and understood before any work is performed. This manual should be made accessible to all applicable personnel in a conspicuous fashion. Resellers & Buyers agree to also include this entire document to instruct Users on the safe and proper usage of the product.

Observe any National / Regional regulations concerning safety and accident prevention.

Table of Contents

Company Address	3
General	3
Who Should Study These Instructions?	3
Safety Instructions	3
Other Signs and Symbols Used in the Instructions	3
General Safety Instructions	4
Exclusion of Liability	5
Modifications & Conversions	5
EC Machinery Directive	5
Technical Changes	5
Intended Use	5
Improper Use	6
Qualified Personnel	6
Short Description	7
Item Number	7
Tightening Torques	9
Transport and Handling	10
Mounting Instructions	10
Preparing the Installation	10
Installation of Servo-Worm Reducer	11
Mounting the Output Shaft (Version with Compression Coupling)	12
Installing the Output Pinion Shaft (Keyed Version)	13
Mounting the Input Coupling on the Motor Shaft	14
Mounting the Motor	15
Check List - Start-Up	16
Start-Up / Operation	17
Maintenance	17
Maintenance Intervals	18
Shaft Seals	18
Changing the Gear Oil	19
Cleaning	21
Troubleshooting	22



ATLANTA

Handling, Installation, Operation & Maintenance Instructions

BWS 110e

4100-001-12.93

Department	TB
Rev. Index	G / Beh.
Date	2009-01-05

E Servo-Worm Reducers

Page	3	23
Name	Behrens	2008-05-20
Released	Lorch	2008-05-08

Company Address:

ATLANTA Drive Systems Inc.
1775 Route 34, Unit D-10
Farmingdale, NJ 07727
USA

Telephone (732) 282-0480
Fax (732) 282-0450
E-Mail info@atlantadrives.com
Internet www.atlantadrives.com

General:

This document is based on information available at the time of its publication. While efforts have been made to be accurate, the information contained herein does not purport to cover all details or variations, nor to provide for every possible contingency in connection with handling, installation, operation, or maintenance.

Who Should Study These Instructions?:

These instructions are addressed to all persons handling, installing, operating or maintaining the ATLANTA E Servo Worm Reducers. You must not use these reducers before having read and understood all of these instructions. These instructions should be given to all applicable personnel and kept for future reference.

Safety Instructions:

The following safety symbols and words are used throughout the instructions to warn and inform of a hazard:



Warns you about high injury hazards



Warns you about possible injury hazards



Warns you about minor injury hazards and/or damage hazards



Transport: Warns you of injury hazards when transporting and handling of heavy and bulky objects.



Environmentally Hazard: Warns you of a pollution hazard for the environment.

Other Signs and Symbols Used in the Instructions:



 A "handling instruction" in which you are asked to do something.

 A "suggestion" shows you a possible simplification or improvement.



Maintenance: Suggests optimal operation.



When operated in  areas with explosion hazard, the instructions identified by the  symbol are to be observed. These were prepared on the basis of the ignition danger rating KGA 102.



ATLANTA

Handling, Installation, Operation & Maintenance Instructions

BWS 110e

4100-001-12.93

Department	TB
Rev. Index	G / Beh.
Date	2009-01-05

E Servo-Worm Reducers

Page	4	23
Name	Behrens	2008-05-20
Released	Lorch	2008-05-08

General Safety Instructions:

The Servo-Worm Reducers incorporate the latest technological development at the time of delivery and can be principally regarded as safe to operate, but below instructions should be observed.



WARNING Improper performance of the work may cause personal injury and material damage.

- ☞ Installation, maintenance and disassembly of rack and pinion drive must only be carried out by skilled personnel with the necessary knowhow and experience.



DANGER Contact with sharp edges may cause serious personal injury!

- ☞ Always wear safety helmet, goggles, protective gloves and safety shoes when handling this product.



WARNING Flying debris can cause grave personal injury and damages!

- ☞ Before starting the drive system, make sure there is no debris or tools nearby.



WARNING Contact with hot surfaces may cause burns!

- ☞ Never touch surfaces which have high operating temperatures. Use extreme care and suitable protective equipment (e.g. gloves)



CAUTION Loose or incorrectly tightened screws can cause damage.

- ☞ Check that all screw connections are tightened to the recommended torque using a calibrated torque wrench.



DANGER Moving and rotating machinery may cause personal injury by being caught or pulled into a machine!

- ☞ Do not wear loose or hanging clothing
- ☞ Keep a sufficient distance away from moving and rotating machinery.
- ☞ For safety, Buyer or User should provide protective safety guards for all moving machinery. The User is responsible for checking all applicable local safety codes and providing suitable guards. Failure to do so may result in bodily injury and/or damage.



WARNING Unintentional machine starting during maintenance work can lead to serious injury! Insure lock-out/tag-out procedures are in place.

- ☞ Make sure that all safety devices are active and operational, and no one can start the machine while people are working on it.



ATLANTA

Handling, Installation, Operation & Maintenance Instructions

BWS 110e

4100-001-12.93

Department	TB
Rev. Index	G / Beh.
Date	2009-01-05

E Servo-Worm Reducers

Page	5	23
Name	Behrens	2008-05-20
Released	Lorch	2008-05-08



WARNING Never install or operate defective products.

☞ In case of defects seen in products, please contact ATLANTA immediately.



Lubricants are hazardous substances that can contaminate soil and water.

☞ Dispose of the lubricants as required by national regulations.

Exclusion of Liability:

ATLANTA will not assume any liability for damage or injuries resulting from improper use or handling of the E Servo-Worm Reducers. Buyer assumes all risk and liability for loss, damage or injury to persons or property of buyer or others arising out of use or possession of any product sold hereunder. Any improper use or handling not in accordance with these instructions may impair the quality of the product and will void any warranties contained herein.

Modifications & Conversions:

Modifications and/or conversions of the Servo-Worm Reducers are not permissible unless expressly approved by ATLANTA in writing.

EC Machinery Directive:

As defined by the EC Machinery Directive 98/37 EG, the Servo-Worm Reducers are not considered an autonomous machine but a component to be installed in machines. Within the purview of the EC directive, the Servo-Worm Reducers must not be operated unless the machine into which this product is installed fulfills the requirements of the directive.

Technical Changes:

ATLANTA Drive Systems Inc. reserves the right to make technical changes to improve the product without notice.

Intended Use



CAUTION The ATLANTA E Servo-Worm Reducers may only be used for speed and torque conversion in machines and mechanical equipment under atmospheric pressure conditions. They must not be used outdoors.

The permissible input speed and output torque as well as the permissible additional loads must not be exceeded. The design instructions in the Atlanta servo catalog must be observed. The allowable load capacities are listed in our servo catalog or our website: www.atlantadrives.com.



CAUTION The Buyer shall be solely responsible for determining the adequacy of the Reducers for any & all uses to which Buyer shall apply the product.



CAUTION The drive train containing the Servo-Worm Reducers must be free from critical speed, torsional, or other type vibration, regardless of how induced. The Buyer shall be solely responsible for this analysis.



ATLANTA

Handling, Installation, Operation &
Maintenance Instructions

BWS 110e

4100-001-12.93

Department	TB
Rev. Index	G / Beh.
Date	2009-01-05

E Servo-Worm Reducers

Page	6	23
Name	Behrens	2008-05-20
Released	Lorch	2008-05-08



The reducers must not be used in combination with combustion engines – danger of overheating and inadmissible shock loading!



The reducers are designed to be driven via the worm shaft with ATLANTA special input couplings. An input drive via the worm wheel (hollow output shaft) may be done only after consulting ATLANTA.









The reducers are not to be considered fail safe or self-locking devices & may drive from the output to the input. If these features are required, a properly sized, independent holding device should be utilized.



The reducers must not be used outdoors or under water.



The surface temperature of the reducers must not exceed 80° C (176° F) during operation. When used in areas with  explosion hazard, the temperature of the housing must not exceed 65°C (149° F).

-  If necessary, measure the surface temperature and warn or turn system off when it exceeds 65°C (149° F).
-  The reducers are designed for intermittent operation (S3 acc. to DIN EN 60034-1).
-  Continuous operation (S1 acc. to DIN EN 60034-1) is not permissible without ATLANTA's written approval. Continuous operation is defined by the duty cycle. If it exceeds 30% or is longer than 20 minutes, it is considered continuous operation.
-  When used in areas with explosion hazard the instructions identified by the  symbol are to be observed.

Improper Use

Whenever the above mentioned limits are exceeded (especially higher torque or speed), this shall be considered improper use which is prohibited. It is prohibited to operate the reducers if:

- It is not properly mounted according to these instructions (e.g. mounting of the motor)
- It is not properly installed according to these instructions (e.g. mounting screws)
- The reducer is dirty or does not have sufficient lubrication

Qualified Personnel

Only skilled and trained personnel, being aware of the possible risks, may carry out mounting, installation, start-up, service, and maintenance work. The personnel must have the necessary qualification for the work to be done and must be familiar with mounting, installation, start-up and operation of the product.

The personnel must carefully read, understand and observe the operating instructions and, in particular, the safety instructions. They must also observe the applicable regional and national regulations on safety and accident prevention. The following work should only be carried out only by qualified personnel: transport, storage, installation, connection, start-up, service, maintenance.



ATLANTA

Handling, Installation, Operation & Maintenance Instructions

BWS 110e

4100-001-12.93

Department	TB
Rev. Index	G / Beh.
Date	2009-01-05

E Servo-Worm Reducers

Page	7	23
Name	Behrens	2008-05-20
Released	Lorch	2008-05-08

Short Description

The ATLANTA E Servo-Worm Reducers were developed for use with three-phase AC and DC servo motors. They feature adjustable low-backlash gearing in a aluminium housing for optimal heat dissipation. Robust bearings and high stiffness permit the transmission of high torques and additional forces. The reducers are supplied test-run, backlash checked and thus ready for operation.

The reducers are available with different reduction ratios. Within one reducer size and design, all components, except for the set of wheels, are the same. The last two digits of the item number denote for the nominal reduction ratio. The exact reduction ratio can be seen from the table below:

Item Number	Actual Gear Reduction	Applicable to
59 xx x05	$19/4 = 4.75:1$	All Center Distances
59 xx x07	$27/4 = 6.75:1$	All Center Distances
59 xx x09	$37/4 = 9.75:1$	All Center Distances
59 xx x15	$29/2 = 14.5:1$	All Center Distances
59 xx x20	$39/2 = 19.5:1$	All Center Distances
59 xx x29	$29/1 = 29.0:1$	All Center Distances
59 xx x39	$39/1 = 39.0:1$	All Center Distances
59 xx x50	$50/1 = 50.0:1$	Center Distances 32 & 50 mm
59 xx x52	$52/1 = 52.0:1$	Center Distances 63, 80 and 100 mm

The reducers are available with two output versions: keyed and compression connections

Item Number:

The item number description is as follows:

Example: E Servo-Worm Reducer, $a = 80\text{mm}$, $i = 19.5:1$, compression output

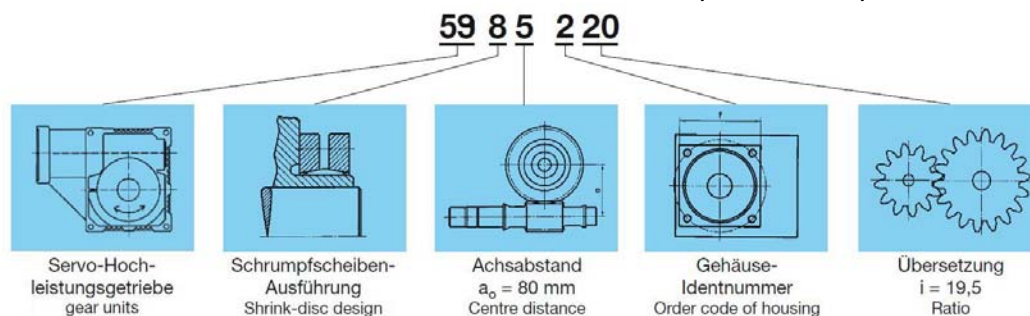



ATLANTA

Handling, Installation, Operation & Maintenance Instructions

BWS 110e

4100-001-12.93

Department	TB
Rev. Index	G / Beh.
Date	2009-01-05

E Servo-Worm Reducers

Page	8	23
Name	Behrens	2008-05-20
Released	Lorch	2008-05-08

Identification:

The Servo-Worm Reducers are identified by a nameplate containing the reducer type, the reduction ratio, the maximum power for S3 operation, the maximum speed for S3 operation, the assembly date, and the serial number of the reducer:

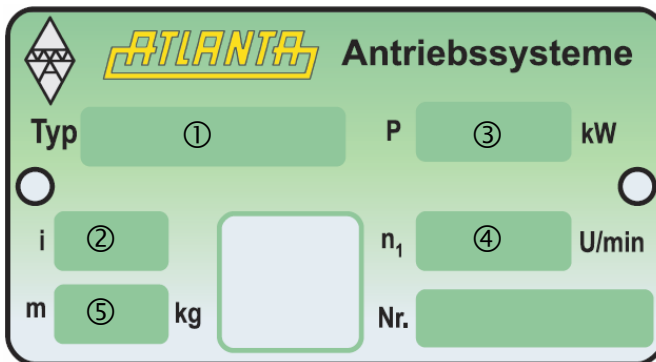

- ① Type
- ② Reduction Ratio
- ③ Max. Power for S3 operation [kW]
- ④ Max. Speed for S3 operation [rpm]
- ⑤ Mass [kg]
- ⑥ Serial Number

Alternatively:

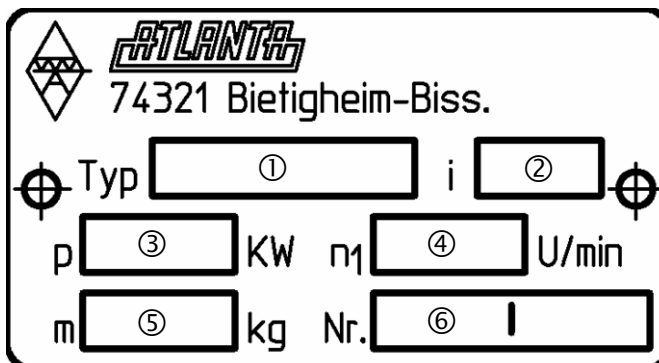

- ① Type
- ② Reduction Ratio
- ③ Max. Power for S3 operation [kW]
- ④ Max. Speed for S3 operation [rpm]
- ⑤ Mass [kg]
- ⑥ Serial Number

A separate oil-rating plate specifies the type of oil:



Alternatively:





ATLANTA

Handling, Installation, Operation & Maintenance Instructions

BWS 110e

4100-001-12.93

Department	TB
Rev. Index	G / Beh.
Date	2009-01-05

E Servo-Worm Reducers

Page	9	23
Name	Behrens	2008-05-20
Released	Lorch	2008-05-08

⊕ When used in ⊕ areas with explosion hazard, the reducer must be adequately identified by a means of a nameplate. Only then it may be used in such areas:

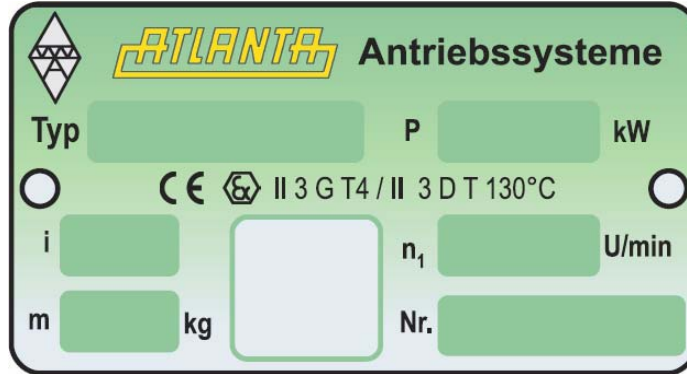

Alternatively with supplementary nameplate:

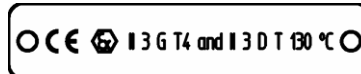

Tightening Torques:

All screw connections for which tightening torques are specified are to be tightened and checked with a calibrated torque wrench. For mounting screws according to DIN912, you can use the following table:



If an internal Standard is used to tighten the screws by using 90% of the strength of the screw, a suitable washer or sleeve has to be used.

For the counterbored holes:

Socket Head Cap Screws DIN912 Class 8.8 / Aluminum Housing	M5	M6	M8	M10	M12	M16
Tightening Torque in Nm ¹⁾	3.5	8.9	18.8	40	45	117
Tightening Torque in lb.ft. ¹⁾	2.5	6.5	13.8	29.5	33.2	86.3

For the threaded holes:

(Effective length of thread min. 1.5 x d_{nom} / bearing surface steel with min. p_G > 500 N/mm²)

Screws DIN912 Class 8.8 / Aluminum Housing	M5	M6	M8	M10	M12	M16
Tightening Torque in Nm ¹⁾	5.5	9.5	23	46	80	195
Tightening Torque in lb.ft. ¹⁾	4.0	7.0	16.9	33.9	59	144

¹⁾ Use only calibrated torque wrenches! If the tightening torque is too low, the required torque will not be transmitted. If the tightening torque is too high, the screws will be overstrained and become unusable.



ATLANTA

Handling, Installation, Operation & Maintenance Instructions

BWS 110e

4100-001-12.93

Department	TB
Rev. Index	G / Beh.
Date	2009-01-05

E Servo-Worm Reducers

Page	10	23
Name	Behrens	2008-05-20
Released	Lorch	2008-05-08

Transport and Handling:



WARNING Always wear safety helmet, goggles, protective gloves, and safety shoes when handling the reducers.

There are no special holes provided for transporting and handling the reducer. However, there are numerous threaded holes in the housing where eye-bolts can be attached, so it is possible to handle the reducer safely.

- ☞ Observe all safety regulations for transport and handling using lifting equipment.
- ☞ Make sure that the load is handled and set down slowly and carefully.

Reducer Center Distance	Weight of Reducer (without accessories)
32 mm	≈ 4.5 kg = 10 lb.
50 mm	≈ 8 kg = 20 lb.
63 mm	≈ 13 kg = 30 lb.
80 mm	≈ 30 kg = 66 lb.
100 mm	≈ 35 kg = 73 lb.



Mounting Instructions:



CAUTION Mounting and installation work may only be carried out by skilled or specially trained personnel. See section "Qualified Personnel"

Preparing the Installation

- ☞ Check the reducer for damage or soiling on the outside.



ATLANTA

Handling, Installation, Operation & Maintenance Instructions

BWS 110e

4100-001-12.93

Department	TB
Rev. Index	G / Beh.
Date	2009-01-05

E Servo-Worm Reducers

Page	11	23
Name	Behrens	2008-05-20
Released	Lorch	2008-05-08

CAUTION

A damaged or dirty reducer must not be installed or operated.

CAUTION

The reducer, especially the area of the seals, must not be cleaned with sharp-edged objects or cleansing liquids.

CAUTION

If the reducer is cleaned in the area of the seals with a cleansing agent approved by ATLANTA, the cleaned surfaces must be protected again against corrosion.

Installation of Servo-Worm Reducer

There are 5 machined mounting faces with adequately sized mounting holes and tapped holes. It is important to ensure tension-free mounting. Use all of the mounting holes of the pertinent contact face. Mounting screws are to be tightened to the specified torque and secured. The correct tightening torque can be seen from the respective tables. Special attention should be paid to the strength class of the screws and the material of the supporting surfaces.

If external forces are to be fully applied, the reducer should be attached to the largest contact face, i.e. to one of the two side surfaces. Mounting the input shaft in a lateral and/or lower position is ideal for lubrication. Mounting the input shaft in a top position will reduce the possible driving power by about 10%. Avoid installing the reducer with the motor hanging downward. In this position, oil could get leak the motor.



CAUTION

Any additional attachments and/or modifications of the reducer are not permissible unless approved by ATLANTA in writing.

CAUTION

Do not use the reducer at ambient temperatures of less than -10 °C and greater than 40°C (less than 14° F and greater than 104° F).

- ⊗ The best area for controlling the maximum surface temperature of the housing is in the area of the input shaft bearing.
- ⊗ The orientation of the input or output shafts vertically downward is only permissible with an oil level monitor stopping the reducer in case of a sudden loss of oil.



ATLANTA

Handling, Installation, Operation & Maintenance Instructions

BWS 110e

4100-001-12.93

Department	TB
Rev. Index	G / Beh.
Date	2009-01-05

E Servo-Worm Reducers

Page	12	23
Name	Behrens	2008-05-20
Released	Lorch	2008-05-08

Mounting the Output Shaft (Compression Version)

For the output shaft, we recommend diameter tolerance of h6 (DIN ISO 286). The material must have a minimum yield point of 385 N/mm² (55.8 kpsi). If you have bought the output shaft from ATLANTA and it is not already mounted, we recommend to proceed as follows:



Reducer without Output Shaft



Reducer with Compression Coupling



Reducer with Output Shaft and Compression Coupling



- Clean the seat of the hollow shaft and oil it slightly (do not use grease). Wipe off any excess oil with a rag.
- Slide the compression coupling onto the hollow shaft.
- ☺ Do not tighten the coupling screws beforehand!
- Clean the shank of the output shaft and oil it slightly. Wipe off any excess oil with a rag.
- Push the shaft into the bore until it is fully seated against the output hub.
- Attach the compression coupling by evenly tightening the screws progressively one after the other (not crosswise).
- ☺ Make sure that the two clamping discs of the compression coupling are parallel!

Several passes are necessary until the screws are tightened to the specified torque in the table below:

Part Number	Tightening Torque *) (Nm)	Tightening Torque *) (in.lb.)
80 81 024	5 Nm	44 in.lb.
80 83 030	5 Nm	44 in.lb.
80 84 036	12 Nm	106 in.lb.
80 85 050	12 Nm	106 in.lb.
80 86 062	12 Nm	106 in.lb.

*) Use only calibrated torque wrenches! If the tightening torque is too low, the required torque will not be transmitted. If the tightening torque is too high, the screws will be overstrained and become unusable.



Dirt may impede the transmission of torque. Do not disassemble the compression coupling before mounting it.



If the reducer is cleaned in the sealing area with a cleansing agent approved by ATLANTA, the surfaces cleaned must be protected again against corrosion.



ATLANTA

Handling, Installation, Operation & Maintenance Instructions

BWS 110e

4100-001-12.93

Department	TB
Rev. Index	G / Beh.
Date	2009-01-05

E Servo-Worm Reducers

Page	13	23
Name	Behrens	2008-05-20
Released	Lorch	2008-05-08



The pressure from the coupling can deform the hollow shaft. Always install the output shaft before tightening the screws of the coupling.



Misalignment of the shafts may cause damage. Make sure that the hollow shaft and the output shaft are aligned.

⊕ When used in areas with explosion hazard the improper installation may lead to inadmissibly high temperatures. Check the tightening torques and axial fixing after 10 hours under operating conditions.

Installing the Output Pinion Shaft (Keyed Version)

Unless the pinion shaft comes already fully assembled, we recommend to proceed as follows:

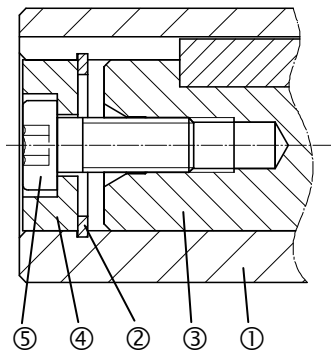

- Clean the seat and the plane surface of the hollow shaft ① and rub it in with MoS₂-powder or grease (reduces fretting corrosion).
- Insert the snap ring ② into the groove of the hollow shaft ①.
- Push the shaft ③ into the bore until it is fully seated against the output hub
- Insert the washer ④ from the opposite side up to the snap ring inside the hollow shaft ①.
- Tighten the screw ⑤ to lock the washer ④ and the output shaft ③.
- Secure the screw ⑤ using suitable adhesive (e.g. Loctite 243)



Reducer



Insert Snap Ring



Insert Output Shaft

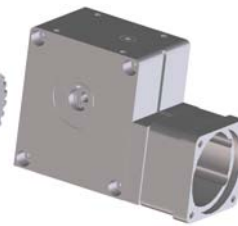

Assemble Washer and Screw

Socket Head Cap Screws (DIN912, Class 8.8)	M5	M8	M12	M16
Tightening Torque in Nm ^{*)}	5.5	23	80	195
Tightening Torque in lb.ft. ^{*)}	4.0	17.0	59	144

^{*)} Use only calibrated torque wrenches! If the tightening torque is too low, the required torque will not be transmitted. If the tightening torque is too high, the screws will be overstrained and become unusable.



Misalignment of the shafts may cause damage! Make sure that the hollow shaft and the output shaft are aligned. Do not press output shaft into place. Use only suitable tools and devices.



ATLANTA

Handling, Installation, Operation & Maintenance Instructions

BWS 110e

4100-001-12.93

Department	TB
Rev. Index	G / Beh.
Date	2009-01-05

E Servo-Worm Reducers

Page	14	23
Name	Behrens	2008-05-20
Released	Lorch	2008-05-08

Mounting the Input Coupling on the Motor Shaft:

ATLANTA special input couplings 65 4X XXX and 65 5X XXX comes pre-assembled.

- Before mounting the input coupling on the motor shaft, clean all contact surfaces and coat them with a thin oil film (no grease). Any excess oil should be wiped off with a rag.
- Rub the spline of the input coupling with MoS₂ powder or grease, which reduces fretting corrosion.
- If the motor shaft has a key, it should be removed.
- For the 65 5X XXX coupling, slide the coupling onto the motor shaft to the "X1" dimension specified in the catalog; for the 65 4X XXX, slide the coupling right up to the shoulder or retaining ring.
- For the 65 5X XXX coupling, intermediate sleeves may be used to reach the motor shaft diameter. The slot in the intermediate sleeve must be aligned with the slot in the coupling.
- Slightly tighten the clamping screws. For the 65 4X XXX coupling, tighten the screws uniformly in a crosswise pattern.
- Check the input coupling for true running at the reference diameter ($f_r < 0.04 \text{ mm}$).
- Several passes are necessary until the screws are tightened to the tightening torque specified in the table below.
- For the 65 4X XXX coupling, make sure that the width of the gap between input coupling and pressure surface remains uniform.
- Check at reference diameter for true running.

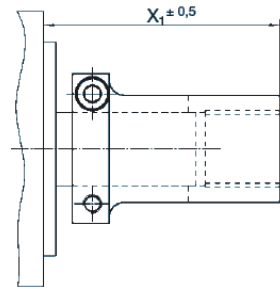

65 5X XXX



65 4X XXX

Order Code	Tightening Torque *)	
65 51 xxx	7 Nm	62 in.lb.
65 53 xxx	7 Nm	62 in.lb.
65 54 xxx	10 Nm	88.5 in.lb.
65 55 xxx	25 Nm	221 in.lb.

Order Code	Tightening Torque *)	
65 43 xxx	7 Nm	62 in.lb.
65 44 xxx	10 Nm	88.5 in.lb.
65 46 xxx	10 Nm	88.5 in.lb.
65 47 xxx	25 Nm	221 in.lb.

*) Use only calibrated torque wrenches! If the tightening torque is too low, the required torque will not be transmitted. If the tightening torque is too high, the screws will be overstrained and become unusable.

⊗ When used in areas with explosion hazard, improper installation may lead to high temperatures (see ignition danger rating according to KGA 114). Check the tightening torques and the axial fixing after 10 hrs work under operating.

⊗ When used in areas with explosion hazard, use corrosion-protected screws.



ATLANTA

Handling, Installation, Operation &
Maintenance Instructions

BWS 110e

4100-001-12.93

Department	TB
Rev. Index	G / Beh.
Date	2009-01-05

E Servo-Worm Reducers

Page	15	23
Name	Behrens	2008-05-20
Released	Lorch	2008-05-08

Mounting the Motor:

- Before mounting on the motor on the reducer, clean all contact surfaces.
 - Slide the motor, with input coupling mounted, onto the splined teeth of the input shaft and into the flange pilot diameter so that the plane surfaces touch.
 - If necessary, rotate the motor shaft until the input coupling and the splined input shaft mesh.
- ☞ The motor must slide on easily.
- ☞ There must not be any gap between the motor and the reducer flange.



Mounting motors with longer shafts than permissible for the respective reducer leads to interference which will damage the motor and the reducer!

- ☞ Check the interfering edges by checking the dimension according to our catalog data and the motor manufacturer's data, or contact ATLANTA.



Clean mating surfaces on motor and reducer,
Wipe clutch profile with MoS₂ powder or grease

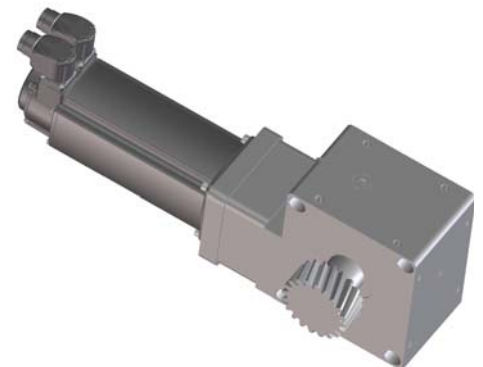

Attach motor to reducer, ensure
proper screw tightening torque

- Tighten screws between motor and reducer to the specified torque. The correct tightening torque can be seen from the respective tables. In this context it is particularly important to pay special attention to the strength class of the screws and the material of the supporting surfaces.
 - The motor can be mounted optimally centered by positioning the reducer in such a way that the input shaft is vertically up.
- ☺ Use screws with an effective length of at least 1.6 x thread diameter.
- ⊠ When used in areas with explosion hazard, use corrosion-protected screws.



ATLANTA

Handling, Installation, Operation & Maintenance Instructions

BWS 110e

4100-001-12.93

Department	TB
Rev. Index	G / Beh.
Date	2009-01-05

E Servo-Worm Reducers

Page	16	23
Name	Behrens	2008-05-20
Released	Lorch	2008-05-08

Check List - Start-Up:

Before Starting Up

What has to be checked?	Checked
Delivery: <ul style="list-style-type: none"> • Are the items in conformity with the packing slip? • Any shipping damage should be reported immediately to the carrier. • Obvious defects or problems should be reported immediately to ATLANTA Drive Systems Inc. 	
Ex Ex Application in areas with explosion hazard: <ul style="list-style-type: none"> • Is the following data on the nameplate of the reducers/motors in conformity with the permissible "Ex" application area on the site? <ul style="list-style-type: none"> • Explosion group • Category • Zone • Temperature class • Maximum surface temperature 	
Ambient temperature: <ul style="list-style-type: none"> • Is the ambient temperature range according to the data on the lubricant table observed? • The maximum ambient temperature of 40° C (104° F) must not be exceeded throughout the whole operating time. • The temperature must not fall below the minimum ambient temperature of -10°C (14° F) throughout the whole operating time. 	
Ventilation: <ul style="list-style-type: none"> • Is sufficient ventilation of the reducer ensured? 	
Ex Input and Output Drive Elements: <ul style="list-style-type: none"> • Are all input and output drive elements to be mounted suitable for the specific "ex" protection use? 	
Nameplate Information: <ul style="list-style-type: none"> • Is the data on the reducer nameplate not exceeded? 	

During Start-Up

What has to be checked?	Checked
Environment: <ul style="list-style-type: none"> • It must be ensured that there are no oils, acids, gases, vapours, or combustible dusts around which may explode! 	
Temperature Measurement: The temperature must be measured after 3 hours of operation under maximum operating load conditions! <ul style="list-style-type: none"> • The temperature measurements shall be taken in the input side in places which do not have the cooling air current. It is advisable to measure in various places in order to determine the maximum. • The absolute temperature of 80° C (176° F) on the surface of the reducer must not be exceeded so that the thermal stress on shaft seals and lubricants is kept low; this has a positive influence on the service life. 	



ATLANTA

Handling, Installation, Operation & Maintenance Instructions

BWS 110e

4100-001-12.93

Department	TB
Rev. Index	G / Beh.
Date	2009-01-05



E Servo-Worm Reducers

Page	17	23
Name	Behrens	2008-05-20
Released	Lorch	2008-05-08

Start-Up / Operation:

☞ Please observe the instructions in the section "General Safety Instructions"

Make sure that the following conditions for the start-up operation are fulfilled:

- The control and safety systems must be turned on and operational. This applies also for trial runs and start-up operation.
 - The reducers must not be operated under the following ambient conditions:
 - Explosive atmosphere (Exception CE  II 3 G T4 / II 3 D T 130° C),
 - Oils, Acids, Gases (Exception CE  II 3 G T4 / II 3 D T 130° C)
 - Vapours, Radiation
 - Depending upon the lubricants used, the ambient temperature must be between -10°C and +40°C (14° F to 104° F). If the ambient temperatures lies outside the permissible range, contact ATLANTA Drive Systems Inc.
 - The reducers must not be operated unless sufficient ventilation is ensured to avoid any accumulation of heat.
-  When used in areas with explosion hazard, the operator must ensure that the surface temperature of the reducer does not exceed 65°C.; if necessary, reduce the surface temperature of the housing.



⚠ DANGER

The surface of the reducer can reach temperatures of more than 65° C (149° F) during operation and cause burns! Before touching the reducer, let it cool down to room temperature to make sure that no one can be injured.



⚠ DANGER

Rotating parts can catch pieces of clothing, hair, and members of the body and injure persons. Make sure that no one can be injured due to rotating parts!

Maintenance:

☞ Please observe the instructions in the section "General Safety Instructions"

☞ The machine which uses the Servo-Worm Reducers must be shut down.

☞ Before any work begins, the machine power supply must be disconnected.

☞ Make sure that nobody can start the machine while maintenance work is being performed.

⚠ DANGER

Even short operation of the reducer while maintenance work is being carried out can cause accidents if the safety devices are shut off.

☞ Make sure that all safety devices are mounted and operational.



ATLANTA

Handling, Installation, Operation & Maintenance Instructions

BWS 110e

4100-001-12.93

Department	TB
Rev. Index	G / Beh.
Date	2009-01-05

E Servo-Worm Reducers

Page	18	23
Name	Behrens	2008-05-20
Released	Lorch	2008-05-08

Maintenance Intervals:

Provided that the reducers are used properly as described in the catalog, the E Servo-Worm Reducers are designed and built for 12,000 hours of operation, except for wear parts such as the bearings and the shaft seal rings.

The following maintenance work should be performed for E Servo-Worm Reducers:

Interval	What should be done?
Every 2,000 machine hours, but at least every six months	<ul style="list-style-type: none">• Check the running noise to detect possible defects in the bearings• Inspect the motor flange for leakage• Inspect the seals for leakage. If any leakage is detected, please contact us.
After 5,000 and 8,000 hours, but after 3 years at the latest	<ul style="list-style-type: none">• Replace the shaft seal rings

Visual Inspection:

- ☞ The entire drive system must be visually checked for external damage and leakage.
- ☞ Any defective or leaking components should be repaired immediately.

Shaft Seals:

Shaft seals close the gap between the reducer housing and the rotating shafts. They are wear parts which have to be replaced when they reach the permissible limit of wear. The service life of shaft seals is influenced by a multitude of parameters, such as:

- Peripheral speed at the seal lip
- Temperature
- Internal pressure in the reducer
- Viscosity of the lubricant
- Chemical analysis and additives of lubricants
- Mounting orientation (lubricant supply to the seal lip)
- Particles and/or metallic dust in the lubricant
- Material of the shaft seal ring
- External pollution
- Damage incurred during replacement

The multitude of influencing parameters makes it practically impossible to predict the precise service life without making experiments simulating the respective application. As the service life of the shaft seals is subject to the above mentioned fluctuations, it is



ATLANTA

Handling, Installation, Operation &
Maintenance Instructions

BWS 110e

4100-001-12.93

Department	TB
Rev. Index	G / Beh.
Date	2009-01-05

E Servo-Worm Reducers

Page	19	23
Name	Behrens	2008-05-20
Released	Lorch	2008-05-08

absolutely necessary to check them at regular intervals. Only regular checks can prevent unnoticed loss of lubricant in the reducer.

Whenever the shaft seals are replaced, you should also check the running surface of the lips of the seal on the shaft. If marks are visible, the shaft must be repaired or replaced. Alternatively, it is possible to insert the shaft seals so that the lip of the seal runs in a practically new position.

Changing the Gear Oil:

A sufficient amount of lubricant is absolutely necessary for safe operation. The lubricant ensures that dry running and, consequently, excessively high surface temperatures, wear (play), or sparking is prevented. The reducer oil level must be checked regularly to insure that there is not any unnoticed loss of lubricant.

ATLANTA E Servo-Worm Reducers are supplied filled with synthetic polyglycol oil (ISO VG 220). The type of lubricant filled in is indicated on the oil-rating plate. Under the following preconditions, this is lifetime lubrication:

- The machine design is strictly in accordance with the guidelines given in the servo catalog, or on our website: www.atlantadrives.com.
- The reducer is exclusively operated within the permissible load and speed ratings in our servo catalog, or on our website: www.atlantadrives.com.
- The operator checks the reducer regularly (every 2 weeks) for loss of oil.
- The surface temperature must not exceed max. 80°C (176° F) during operation.
- ☺ In the case of operation with low input speeds (< 400 rpm for 50 mm reducer, < 300 rpm for 63 mm reducer, < 250 rpm for 80 mm reducer, < 200 rpm for 100 mm reducer, and < 150 rpm for 125 mm reducer), we recommend to change the lubricant every two years.

CAUTION Synthetic oils are not mixable with mineral oils.

We recommend using the following lubricants:

Manufacturer	Lubricant	Internet Address
Klüber	Klübersynth GH6 – 220	www.klueber.de
Aral	Degol GS 220	www.aral.de
BP	Energol SG – XP 220	www.bp.de
DEA	Polydea PGL P220	www.dea.de
Optimol	Optiflex A 220	www.optimol.de
Shell	Tivela Öl S220	www.shell.com
Tribol	800/220	www.castrol-industrie.com

Item number for 1 liter of Klübersynth GH6-220 is 65.90.010.



ATLANTA

Handling, Installation, Operation &
Maintenance Instructions

BWS 110e

4100-001-12.93

Department	TB
Rev. Index	G / Beh.
Date	2009-01-05

E Servo-Worm Reducers

Page	20	23
Name	Behrens	2008-05-20
Released	Lorch	2008-05-08

For quantity of lubricant needed, see the table below:

Reducer Center Distance	Oil Quantity (liters)
32 mm	0.1 l
50 mm	0.3 l
63 mm	0.5 l
80 mm	1.2 l
100 mm	2.0 l



Contact with synthetic grease and oils can lead to skin irritation.

- ☞ Avoid extended contact with oils and/or grease and clean any oily patches of skin thoroughly.



Hot oil and reducers can cause severe burns! Before touching reducer, please let the reducer cool down to room temperature.

- ☞ Use extreme care and protect yourself from hot oil contact when changing the oil.



Blending different lubricants can deteriorate the lubrication characteristics. This may cause damage to the reducer.

- ☞ Make a complete change of lubricant (including flushing) when you use a different lubricant.



Mineral oils reduce the transmission efficiency and must not be used without consulting ATLANTA.



Lubricants (oils and fats) are dangerous substances which may pollute soil and water.

- ☞ Collect drained off lubricant in suitable containers and dispose of them in accordance with the applicable national regulations.
- ☞ Prevent lubricants from going into drain pipes, sewer and water system.



ATLANTA

Handling, Installation, Operation & Maintenance Instructions

BWS 110e

4100-001-12.93

Department	TB
Rev. Index	G / Beh.
Date	2009-01-05

E Servo-Worm Reducers

Page	21	23
Name	Behrens	2008-05-20
Released	Lorch	2008-05-08





Cleaning:

 Dust deposits of more than 5 mm on the reducer are not permissible because they increase the surface temperature which may result in the ignition of the dust.

 **CAUTION** Cleaning with high-pressure cleaner is not permitted because it destroys the seals so that water may penetrate into the reducer, causing premature failure of the reducer.







 **CAUTION** Cleaning with solvents is permissible only if these have been released by the company ATLANTA Drive Systems Inc. in writing.

Restarting Operation After Maintenance:

-  Please observe the instructions in the section "**General Safety Instructions**"
-  Make sure that all safety devices are mounted and operational.
-  Before releasing the machine again for operation, perform a test run.
-  Look for any forgotten screws and tools and remove them.

Storage:

If the reducer is not installed immediately after its delivery, the following should be done:

-  Store the reducer in a cool, dry place, with the input shaft on top and output shaft horizontal so it doesn't come into contact with any other objects.
-  Protect the reducer against environmental influences (ozone, UV light, electric welding, dust, dirt, moisture, temperature fluctuations (32°F to +86°F), shocks, etc.).
-  Accessories, such as input coupling or output shaft, are to be stored separately.
-  Protect the steel parts against corrosion with a rust inhibitor.
-  For store-keeping, we recommend the "First In – First Out" principle.
-  Occasionally turn the input shaft of the reducer to coat the internal parts and free seals.
-  The maximum storage time under such conditions is two years.



ATLANTA

Handling, Installation, Operation & Maintenance Instructions

BWS 110e

4100-001-12.93

Department	TB
Rev. Index	G / Beh.
Date	2009-01-05

E Servo-Worm Reducers

Page	22	23
Name	Behrens	2008-05-20
Released	Lorch	2008-05-08

Troubleshooting:

You should take immediate action if you see oil loss, increased operating noises or increased operating temperatures. Any problems occurring during the warranty period requiring the repair of the reducer may only be remedied by ATLANTA. We also recommend to ask for our assistance after the warranty has expired.



Always shut down the reducer when problems are seen. Secure the motor against inadvertant starting & post a notice on control panel. Insure lock-out/tag-out procedures are in place.

Problem	Possible Cause	Remedy
Increased Operating Temperature	Design to insufficient; Speed / torque too high	Check the technical data
	Motor heats up the reducer	Check the attachment circuit, replace the motor, or provide an insulation between motor and reducer
	Ambient temperature too high	Ensure adequate cooling
	Duty cycle too long	Ensure adequate cooling
Increased Operating Noise	Defective bearing	Please contact us
	Defective tooth system	
	Reducer mounting has loosened	Tighten screws/nuts with the specified tightening torque. Replace defective screws/ nuts
Loss of Oil	Adjustment of controller	Check the servo-motor parameters
	Leakage	Please contact us
	Apparent leakage	A temporary leakage can happen due to much grease between sealing lip and protective lip. The excess grease can penetrate outside as an apparent leakage.



ATLANTA

Handling, Installation, Operation &
Maintenance Instructions

BWS 110e

4100-001-12.93

Department	TB
Rev. Index	G / Beh.
Date	2009-01-05

E Servo-Worm Reducers

Page	23	23
Name	Behrens	2008-05-20
Released	Lorch	2008-05-08

Disposal:



Dispose of the individual components separately depending on their nature and any existing specific National regulations, such as:

- Steel Scrap
 - Gearwheels
 - Shafts (hollow shafts)
 - Antifriction bearings
 - Cast iron parts
 - Couplings
- Aluminium Scrap
 - Housing elements
 - Adaptor elements
- Bronze Scrap
 - Worm-wheel (separated from hollow shaft)
- Collect waste oil and dispose of as directed

ATLANTA will not assume any liability for damage or injuries resulting from improper use or handling of the E Servo-Worm Reducers. Buyer assumes all risk and liability for loss, damage or injury to persons or property of buyer or others arising out of use or possession of any product sold hereunder. Any improper use or handling not in accordance with these instructions may impair the quality of the product and will void any warranties contained herein.